

Covestro Elastomers

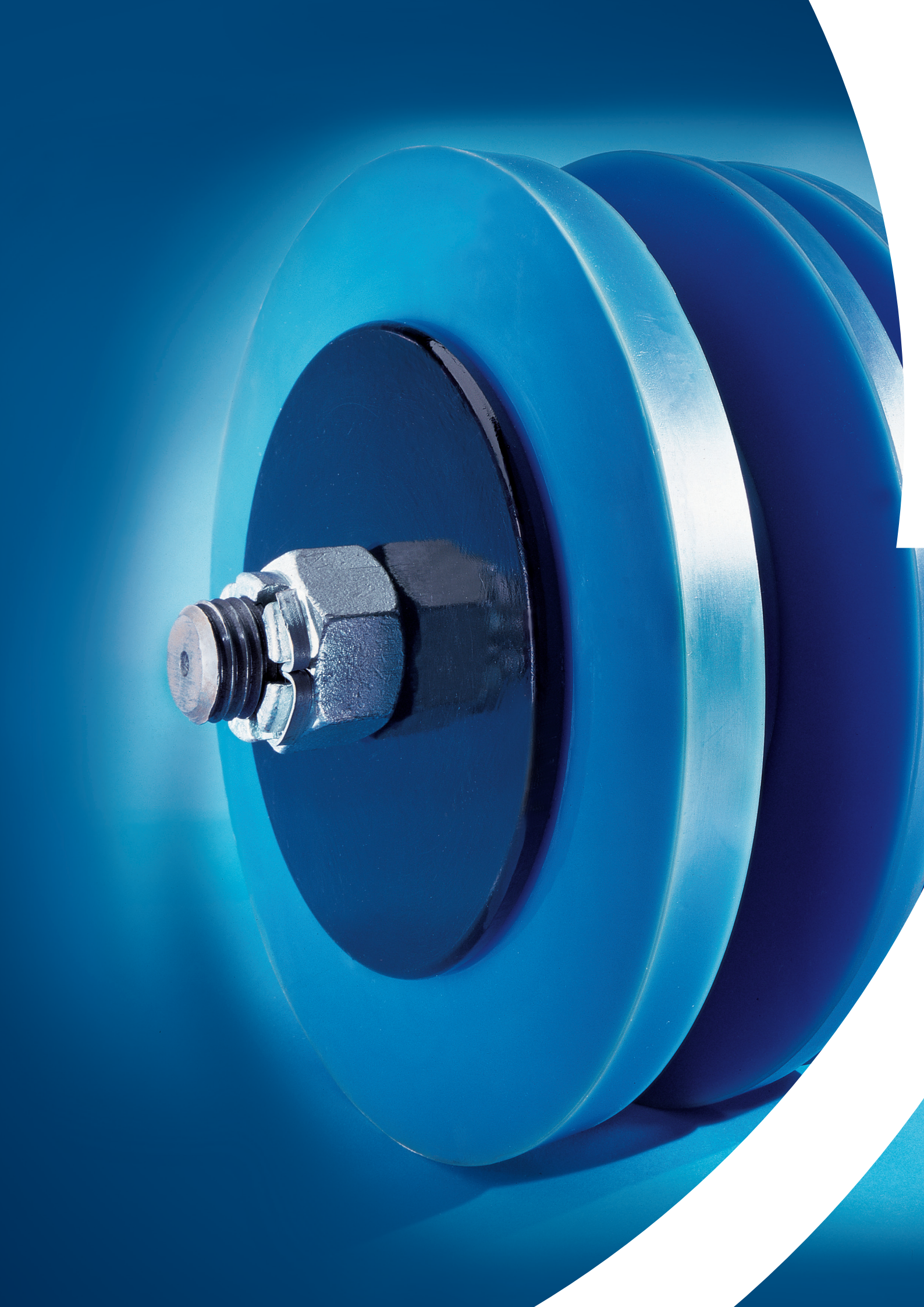



Helping the world to address major challenges

The world is changing rapidly and enormous challenges lie ahead of us. Climate change, resource scarcity, increasing mobility, urbanization, etc. These global mega trends may seem insurmountable, but at Covestro, we prefer to look for the opportunities they represent. We help our customers tackling these challenges through technologies and products that benefit society and reduce the impact on the environment.

Although Covestro's products are quite diverse, they are all designed to underpin the company's vision - to make the world a brighter place. Covestro consists of three businesses, developing and producing the high-tech plastic polycarbonate as well as polyurethanes in their wide variety of foams and in their derivatives as a component for coatings, adhesives and elastomers.

From Desmodur® systems and Vulkollan® to Baulé® machinery, we aim to focus in this brochure on the variety of solutions we offer for superior casting of polyurethane elastomers with a broad range of property profiles and production requirements. We use our expert knowledge and our hands-on mentality to support our customers with high-quality products, reliable services and innovative solutions. Last, but not least, we want to focus on improving the environment and our will to constantly drive the cast polyurethane industry towards more sustainability and safety.

Drawing on our storied history - we invented polyurethane, after all - and the accumulated expertise within the global cast polyurethane elastomers industry, Covestro is fully committed to address the requirements of customers in their versatile application fields through chemistry and machinery.

History

A proud past, a bright future

You can't write the history of polyurethane without Covestro. We invented polyurethane and developed the landmark polyisocyanate-polyaddition process. As the developer of polyurethane lacquers, casting elastomers, adhesives and rigid polyurethane foams, Covestro has been at the forefront of industry innovation and product development for more than 150 years.

On a similar trajectory, Baulé leveraged early success in the cast polyurethane industry to produce customized prepolymers and dispensing machines before developing ground-breaking

innovations in elastomers. Recognizing their synergies, Baulé and Covestro (formerly known as Bayer MaterialScience) agreed to join forces in 2008, bringing together the global network and long-term experience of Covestro with the extensive processing knowledge of Baulé. Subsequently, Covestro fully acquired Baulé in 2012 and integrated it with its existing elastomers business.

Today, we push the limits of technology through a strong focus on innovation. With our extensive application knowledge and strong production network, we are the preferred solution provider. We offer practical expertise in molding, a broad range of cast polyurethane formulations and customized low-pressure dispensing machines.

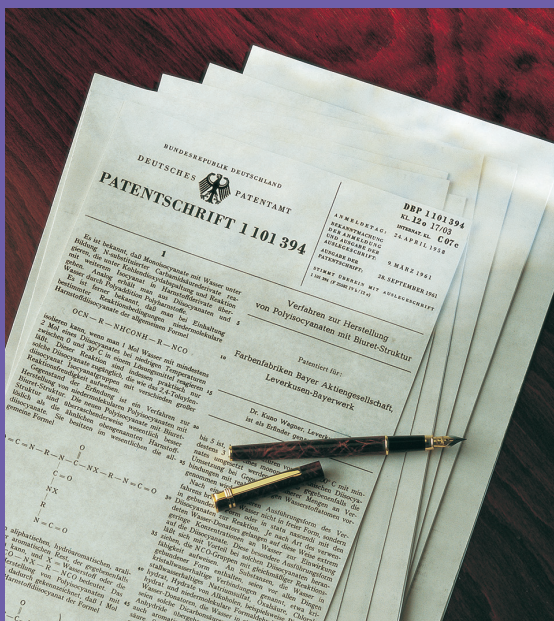

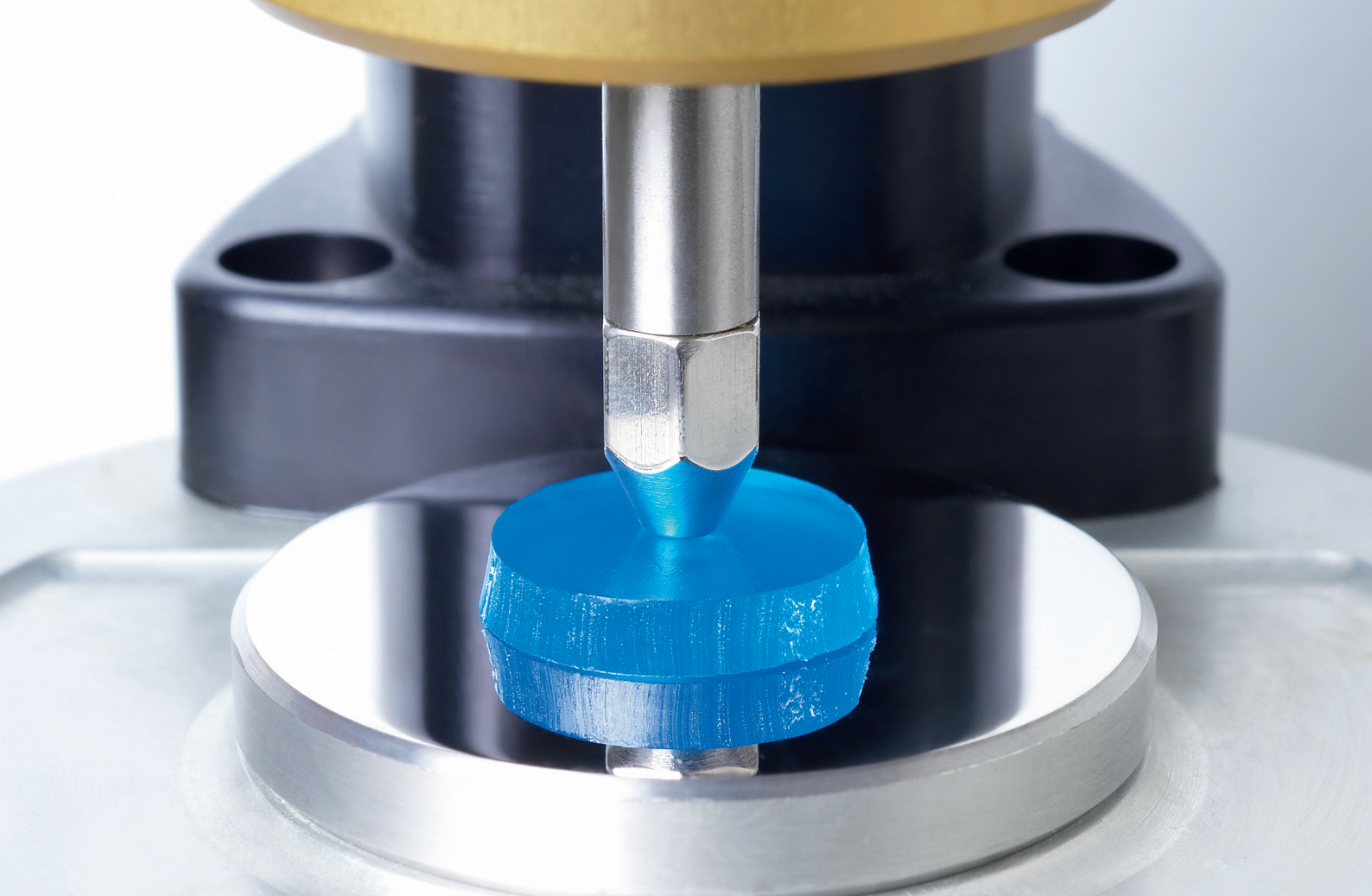

Innovation

Solutions provider through expertise and innovation

With an established international innovation network and a broad range of formulations, Covestro is fully committed to the cast polyurethane industry. We are focused on innovation, which is supported by our historic application knowledge and practical expertise. Innovation remains a core part of Covestro's genetic makeup.

We constantly work to develop the next generation of products, pushing today's limits to further



improve performance. To maintain our leadership in this area, we perform research related to new formulations, new chemicals, machine design and process improvement.

Covestro's investment policy also supports continuous improvement within the area of health, safety, environmental and quality management. We respect environmental regulations and strive to improve hygiene and safety while providing customers with the quality they expect.

System & machine products

Cast polyurethane solutions

Since Otto Bayer's discovery of polyurethane in 1937, this amazingly flexible and durable material has become indispensable in many everyday applications. Because of its excellent properties it has also replaced numerous other materials.

The unique properties of cast polyurethane elastomers make them ideal for a wide range of uses. These include industrial and mechanical

parts as well as applications in mining, oil and gas, printing, material handling and many more industries.

Decades of experience, skills and expertise in the engineering and production of high-quality cast polyurethane solutions come together at Covestro. From Desmodur® systems and Vulkollan® to Baulé® machinery, Covestro offers a broad and unique portfolio of technologies for superior casting of polyurethane elastomers with differing property profile and production requirements.



Manufacturing & services

Global resources and worldwide presence

Our deep-seated knowledge and onsite expertise - driven by being customer focused and living an entrepreneurial spirit - support our customers with high-quality products, reliable service and innovative solutions.

When recommending a polyurethane system, we draw on our expertise and employ a comprehensive business approach to consider every aspect of a customer's set of requirements. Our technical experts have been intensively

trained and are able to address a variety of situations involving machines and/or systems.

With more than 30 state-of-the-art flexible manufacturing sites and an active network of service facilities throughout the world, we are conveniently close to our end users. Our regional technical centers are equipped with a complete range of machines and molding peripherals that enable industrial scale testing, process optimization, prototyping and customer training. We can also help improve customer operations by adapting systems to optimize their production environment in terms of productivity, quality and total cost of ownership.



Research & development

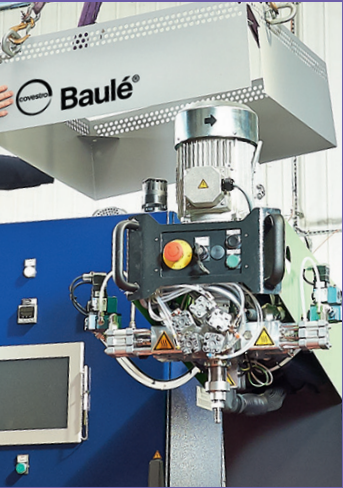

Advanced research and custom development

At Covestro, we are experts in polyurethanes and casting. Every day we put our expertise and innovation to work for our customers. By listening closely to truly understand their needs, we are able to provide custom solutions that result in satisfied and successful customers.



We aim for excellence in customer satisfaction, and to be the partner of choice in the elastomer industry. To maintain our leadership in this area, we perform research related to new formulations, new chemicals, machine design and process improvement. For instance, we can help improve customer operations by adapting systems to optimize their production environment in terms of productivity, quality and total cost of ownership.

Our in-house engineering team is focused on designing machines to be the most-efficient, most-reliable and highest quality tools for cast polyurethane part production.



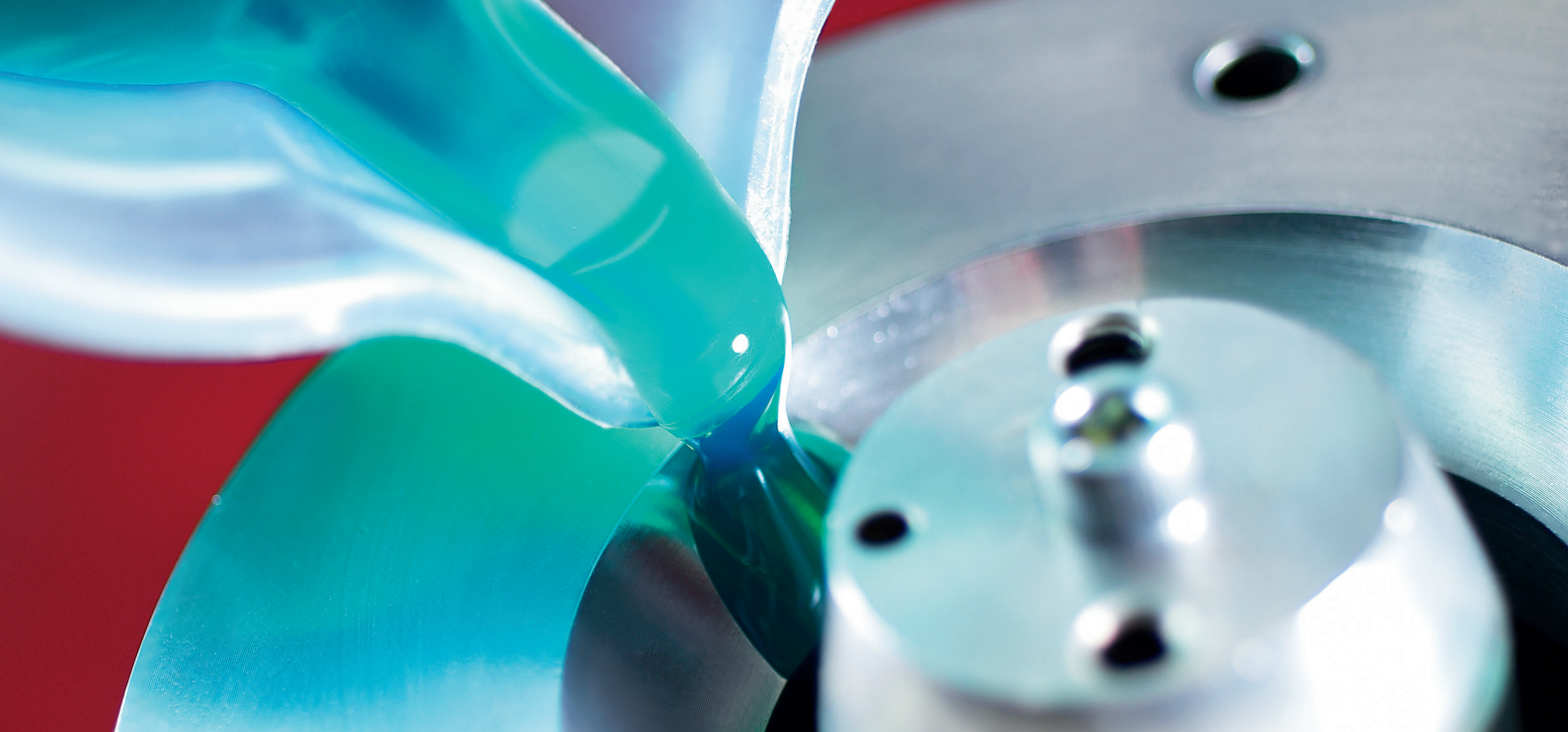

Desmodur[®] systems

Versatility and outstanding performance

Due to their excellent combination of physical properties, polyurethane elastomers are used in a wide range of applications where flexibility and durability are needed. Covestro has been offering Desmodur[®] systems since shortly after polyurethane was first discovered in 1937.

Cast polyurethane elastomers based on Desmodur[®] systems from Covestro provide high abrasion and chemical resistance, load-bearing ability, and tunable flexibility. They can withstand exposure to chemicals and oils, cutting, tearing, sliding and stretching, impacts, and various damaging forces.

Desmodur[®] systems are also offering many combinations in terms of cost, performance and processing conditions. Our prepolymers are specifically designed while using the full range of available raw materials and most advanced technologies. Careful choice of raw materials and preparation conditions play a key role in polyurethane elastomers performance.

- TDI systems, including low unreacted TDI systems
- MDI systems, including unique amine crosslinked systems
- Quasi-MDI systems
- Aliphatic systems
- Cold casting systems
- Rotational Casting systems

Desmodur[®]

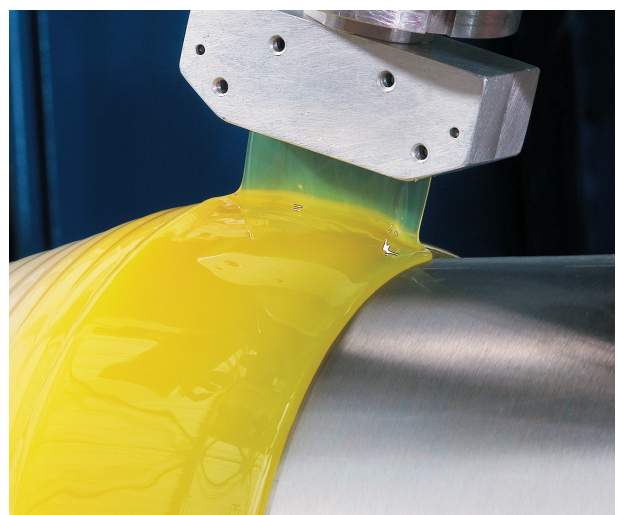
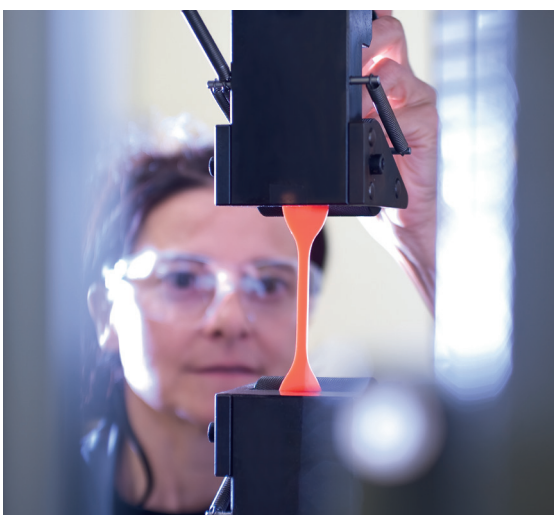

Vulkollan®

Ultimate solid and cellular solutions

Vulkollan® is one of the most powerful elastomers in the market, combining highest mechanical load-bearing characteristics with highest dynamic load-bearing capacity. Therefore, Vulkollan® is preferably used for superior tasks in many technical fields.

Superior material for demanding applications

In a multistage process developed by Covestro, solid Vulkollan® is produced through chemical reactions between polyester polyols of the high-quality Vulkollan® range, Desmodur® 15 and glycols. Desmodur® 15 is the trade name for 1,5-naphthylene di-isocyanate (NDI) from Covestro. The ultra-high-performance elastomer covers a hardness range from approx. 65 Shore A up to 60 Shore D. Vulkollan® can only be manufactured by licensed processors. They produce wheels and castors to deal with highest dynamic loads, technical and semi-finished parts.

Cellular Vulkollan® is produced from Vulkollan® polyols, Desmodur® 15 and water. It covers a

Main characteristics:

- Highest mechanical load-bearing characteristics
- Highest dynamic load-bearing capacity
- High volume compressibility combined with minimal transverse expansion (cellular)

Typical applications

- Wheels & castors
- Couplings
- Squeegees
- Seals & membranes
- Bumpers & springs
- NVH (noise, vibration, harshness) elements

density range from approx. 300 up to 850 kg/m³ and combines high volume compressibility with minimal transverse expansion. Cellular Vulkollan® is used for the manufacture of superior damping elements, such as bumpers, springs and NVH (noise, vibration, harshness) elements.

Besides the classic multistage process, solid and cellular NDI-based cast polyurethane elastomers can also be manufactured from stable NDI-prepolymers offered by Covestro. These products are recommended especially for small- and midscale production.

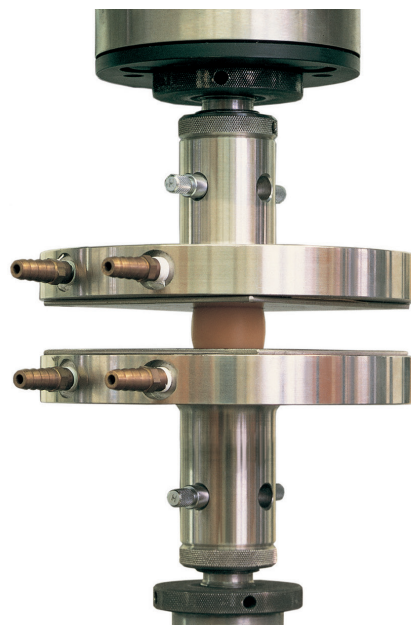
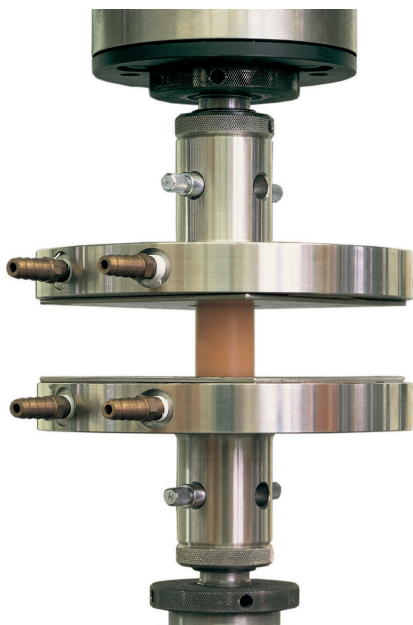

Baulé[®] machines



Scalable equipment at its best

Molding experience, knowledge of polyurethane chemistry and in-house engineering skills are combined to make Baulé[®] machines the most efficient tools for successful cast polyurethane part production. Our cast polyurethane solutions overcome the usual barriers that can occur with production industrialization and offer the possibility to cast quality parts despite chemical or processing restraints. Covestro Elastomers possesses a versatile expertise that is dedicated to providing the right products, but also the adequate process and practical assistance.

Our approach is to have a comprehensive understanding of our customers' needs. When it comes to our dedicated machinery, this concern is reflected in the innovative concept developed around the processing equipment's very constitution: customized to individual requirements, any machine is designed to precisely answer present needs and to flexibly evolve with future ones.

To allow such extensibility and precision, our engineers had to forgo machine ranges to leave the way open for a vast array of functions that can now be combined, deconstructed and rearranged at our customers' discretion.

All Baulé[®] machines meet the requirements for successful cast polyurethane molding : reliable material preparation, precise metering, optimal mixing technology and the highest possible process control.





Embedded innovations

Auto-calibration: effortless accuracy

Eager to lighten the operators' workload and increase process reliability, our engineers developed an auto-calibration mode. Increasing the machines' metering accuracy, this innovative calibration mode is self-driven, which allows the operators to rely on precise parameters and dedicate their full attention to the molding process.

Human-Machine Interface: productivity and performance within hand's reach

Covestro Elastomers' Human-Machine Interface has been entirely remodeled for a more intuitive use, as well as interactive operations between machine, operators and technicians, be it on site or remotely.

Low Exposure & High Performance Ovens

Covestro Baulé® machines now feature the innovative High Performance Oven (HPO), which allows a much faster and accurate heating of the components. This optimized design can also be combined with the Low Exposure Oven (LEO) option which maximizes Covestro Elastomers' safety standards by further reducing the operator's exposure to chemicals when working with the oven.



Human-Machine interface: process information display

A plethora of applications

Covestro's raw materials and systems are designed to meet requirements of a wide range of demanding applications in many industries such as automotive, mining, oil and gas, and renewable energies. Through in-depth research into elastomer behavior in various environments, our team has developed the most innovative and effective products and solutions.

Sports & Leisure

Manufacturers and engineers in the sports and leisure industry require materials that can meet demanding mechanical and dynamic requirements. From roller coasters to skateboards, high-performance polyurethane wheel coverings provide superior strength and reliability.



Industrial

Reliability and durability are important attributes for any material used in an industrial setting. Covestro's cast polyurethane elastomers possess a superior combination of properties. This makes them ideal for a range of industrial applications, delivering the highest quality of durability and service life.



Oil & Gas

Choosing the most durable materials is a key part of developing the highest quality equipment. With decades of polyurethane elastomers experience, Covestro has developed leading material technology that offers excellent properties for various oil and gas applications.

Mines & Quarries

Equipment failure due to a material breakdown is not an option when running continuously such a time intensive production line. Covestro is a proven collaborator with mine and quarry original equipment manufacturers and provides materials that achieve optimal performance and cost efficiency.



Renewable Energies

Renewable energy sources, such as sun and wind, are being adopted at a fast pace. To develop renewable projects, power producers need materials that are strong, durable and can withstand demanding environmental conditions. With an excellent combination of properties, polyurethane elastomers from Covestro help keep critical power projects energized.

Automotive

The automotive industry faces many challenges - greater comfort, safety, cost-efficiency, a longer service life and space-saving designs.

For elastomers, this means outstanding dynamic properties and the combination of high-quality and consistent characteristics. Good deformation behavior, thermal stability and hardly any signs of fatigue under load are also essential characteristics.



Material Handling

From conventional TDI based systems, to dedicated MDI based systems, to the well-known Vulkollan®, Covestro offers raw materials and systems for all material handling applications including wheels, castors, guide rollers and more.



Printing

Covestro offers specific Desmodur® systems and Vulkollan® raw materials for use in a variety of printing applications. The low compression-set of the elastomers, solvent resistance and machinability are a perfect fit for squeegees, can-coating rollers, rollers, doctor blades and more.



Steel Industry

Either in traditional or rotational casting, Covestro's polyurethane elastomer raw materials and systems can meet the required properties in the steel processing industry, including rollers and dampers.

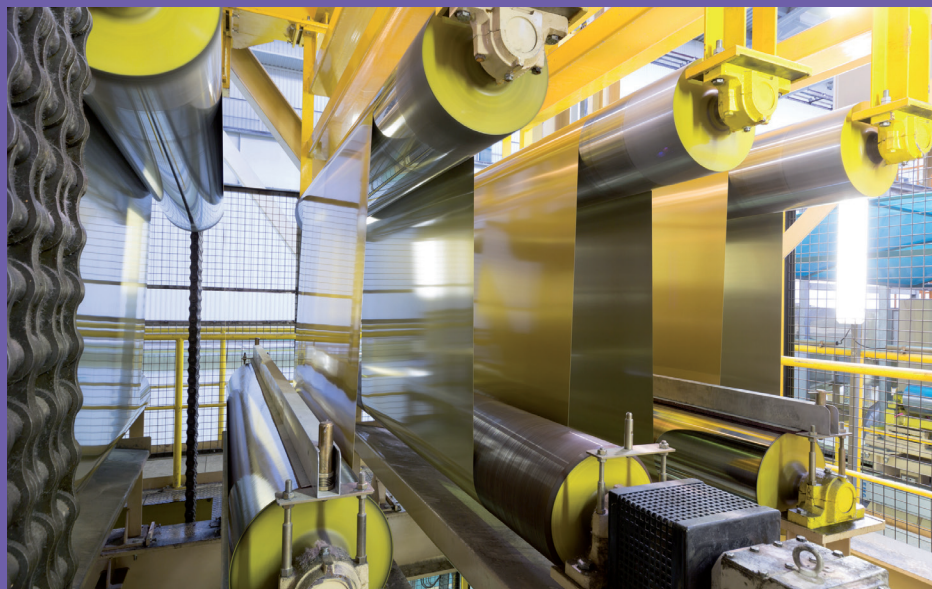



Sales network

Worldwide presence

With a dedicated worldwide production network and extensive global sales and technical support network, Covestro offers its global elastomers customers short delivery times, local presence and flexible service.

We take great pride in always being available, flexible and reactive, supporting our mission to work in partnership with customers to develop long-term relationships. True to our foundation and our more than 150 years of success, we are committed to customer satisfaction in the worldwide cast polyurethane industry.

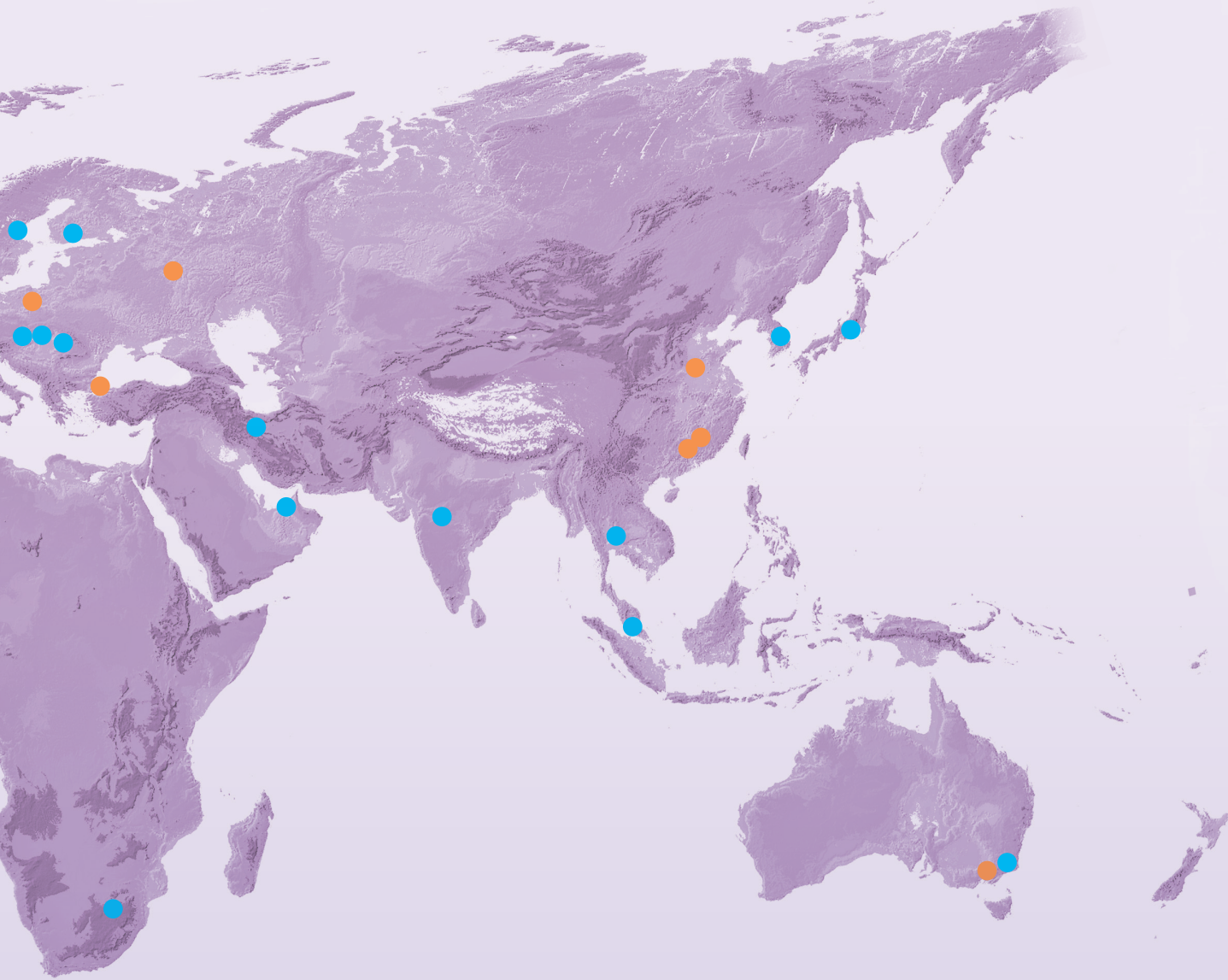

● PRODUCTION AND OFFICE LOCATIONS

● ELASTOMERS DISTRIBUTION NETWORK

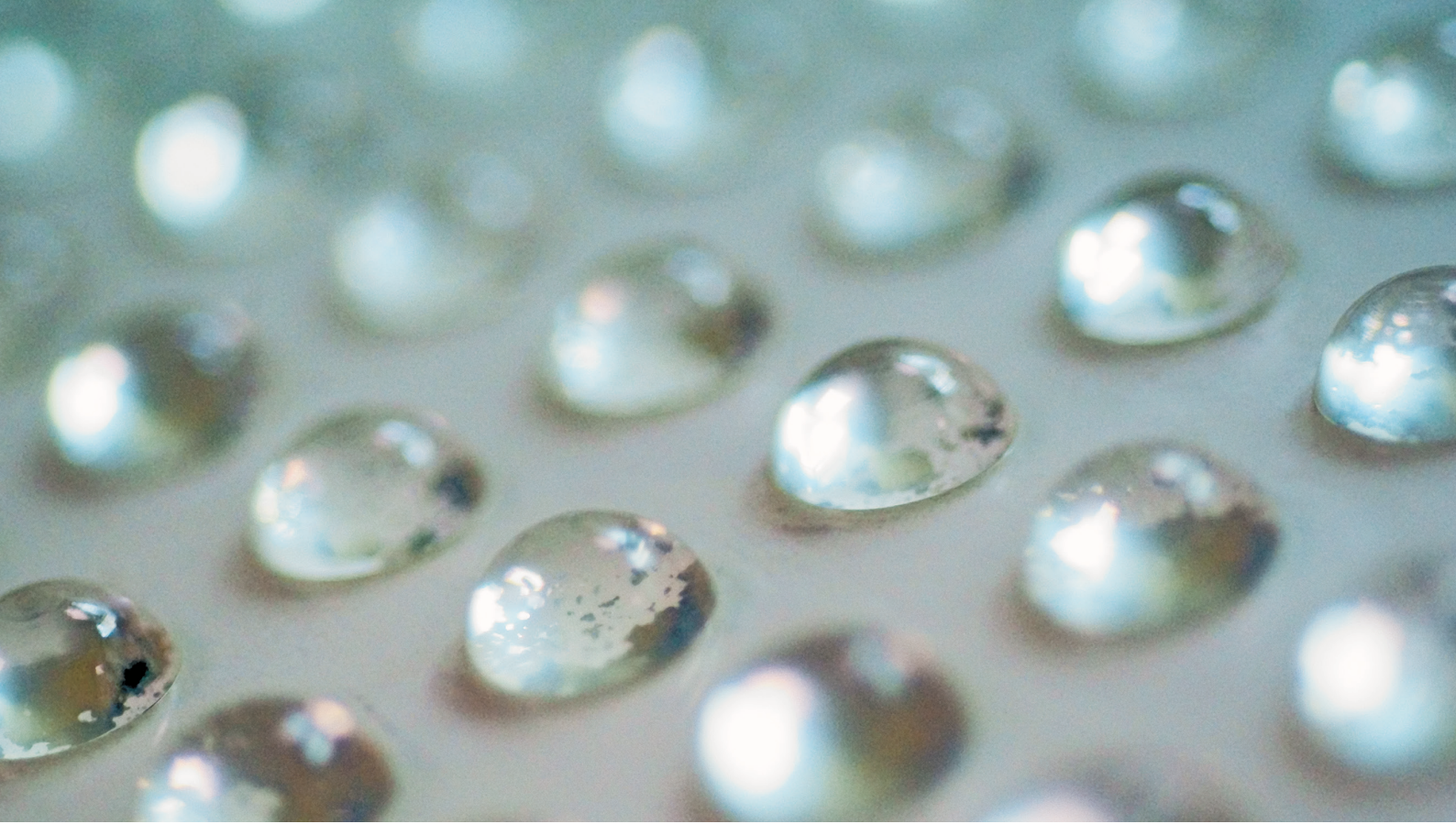

Compliance & Safety

Acting in accordance with the rules

The global nature of Covestro's operations means that our activities are subject to a multitude of statutory regulations and standards throughout the world. That makes corporate compliance a particularly important topic for us. It means acting with integrity and observing the legal and ethical framework at all times.

Taking responsibility, from research to disposal

Preventing injuries and safeguarding the health of all employees in the workplace is one of the main objectives of Covestro. Detailed regulations and precise controls are as much a part of this as safe production processes, plants and transport. There is an equal focus on the protection of the environment and the well-being of all who come into contact with the company's products.

Our Principles of Business Conduct:

- We are committed to fair competition
- We are committed to integrity in business dealings
- We are committed to the principle of sustainability
- We are committed to upholding foreign trade laws
- We are committed to safeguarding equal opportunity in securities trading
- We are committed to proper record-keeping and transparent financial reporting
- We are committed to fair and respectful working conditions
- We are committed to protecting the fruits of our own endeavors and respecting the legally recognized rights of others
- We are committed to keeping corporate and personal interests separate
- We are committed to cooperating with the authorities





Covestro Elastomers Headquarters
46 avenue des Allobroges - BP 116
26103 Romans cedex - FRANCE
+33 4 75 72 72 75
+33 4 75 02 11 73
info.elastomers@covestro.com

elastomers.covestro.com

Edition 2016
Layout: studioval.fr - Photos: ginko-photo.com,
Except P.2: Rolf König, P.10, 11, 12, 13: Shutterstock, Fotolia & iStock,
P.12 (Automotive): Mark Evans

